



Akustická signalizácia A-MAS s 2 spôsobmi montáže je zdrojom intenzívneho akustického signálu, určená do náročných priemyselných podmienok. Osadená je moderným piezoelektrickým meničom s vysokou účinnosťou a nízkym príkonom.

Robustná konštrukcia, vysoký stupeň krytia ju predurčujú k použitiu v náročných priemyselných prevádzkach, pri signalizácii poruchových stavov strojov, havarijných situácií, výstrahách pred nebezpečenstvom, atď. .

- 32 tónov zvukovej signalizácie
- možnosť nastavenie hlasitosti 5 dB až 115 dB
- možnosť vzdialene vypnúť zvukovú signalizáciu
- možnosť vzdialene prepnúť nastavený tón na extra tón

Rozmerový výkres

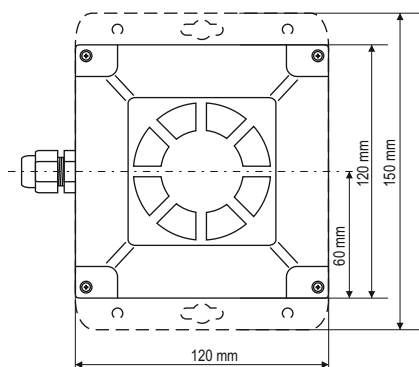
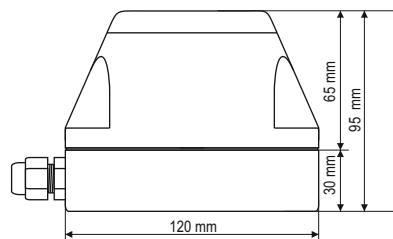
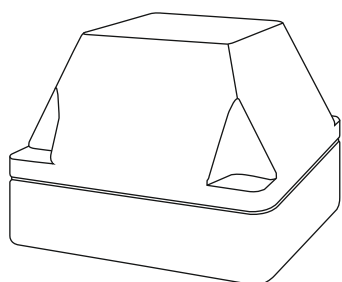

### Objednávacie špecifikácie s úchytni "A"

A-MAS.24.A.1	24V / šedá
A-MAS.24.A.2	24V / červená
A-MAS.230.A.1	230V / šedá
A-MAS.230.A.2	230V / červená

### Objednávacie špecifikácie bez úchytní "B"

































































A-MAS.24.B.1	24V / šedá
A-MAS.24.B.2	24V / červená
A-MAS.230.B.1	230V / šedá
A-MAS.230.B.2	230V / červená

### Technické parametre:

Napájacie napätie:	24V AC/DC 230V AC, 50 Hz
Počet akustických tónov	32
Materiál	PC / RAL 7035 svetlo šedá
Farby vrchnej časti signalizácie	šedá, červená
Krytie	IP 65
Rozsah prac. teplôt	-30 až + 50°C
Priemer prívod. kábla	4 – 8 mm
Rozmery s úchytni	150 x 120 x 95 mm
Rozmery bez úchytní	120 x 120 x 95 mm
Akustický výkon	5-115 dB



**Nastavenie DIP prepínača (húkačka)**

	Položa prepínača	Druh tónu		Frekvencia tónu kHz	Modulácia ton1; ton2
A01		stály ton		2,34kHz	
A02		kizavý ton		800 - 990 Hz	
A03		kizavý ton		787 - 950 Hz	
A04		stály ton		2,77kHz	
A05		kizavý ton		2,36 - 2,67 kHz	
A06		kizavý ton		2,36 - 2,75 kHz	
A07		kizavý ton		521 - 1190 Hz	
A08		kizavý ton		578 - 1150 Hz	
A09		dvojton		2,35 / 2,76 kHz	0,25s ; 0,25s
A10		singl pulz ton		961 Hz	1s ; 1s
A11		dvojton		787Hz , 952 Hz	0,5s ; 0,5s
A12		singl pulz ton		2,78kHz	1s ; 1s
A13		singl pulz ton		961Hz	0,256s ; 1s
A14		stály ton		961 Hz	
A15		dvojton		555Hz, 438Hz	0,5s ; 0,5s
A16		singl pulz ton		653Hz	0,15s; 0,15s
A17		singl pulz ton		653Hz	1,82s ; 1,82s
A18		singl pulz ton		653Hz	6,3s ; 13s
A19		stály ton		653Hz	
A20		dvojton		549Hz , 438Hz	1s ; 1s
A21		singl pulz ton		653Hz	0,5s ; 0,5s
A22		singl pulz ton		2,76kHz	0,15s
A23		sing pulz ton		2,76kHz	0,15s ; 0,1s
A24		kizavý ton		2,37kHz	
A25		tri pulzy		958 Hz	0,5s; 0,5s ; 2s
A26		tri pulzy		2,76kHz	0,5s; 0,5s ; 2s
A27		stály ton		3,82kHz	
A28		kizavý ton		1,98kHz - 2,6kHz	
A29		dvojton		641Hz, 980Hz	0,25s; 0,25s
A30		dvojton		505Hz, 606Hz	0,25s; 0,25s
A31		dvojton		794Hz, 952Hz	0,25s; 0,25s
A32		dvojton		1,18kHz, 790Hz	0,5s ; 0,5s